

ROUND surface

Please scroll down for suspended mounting

MOUNTING INSTRUCTIONS

DO NOT DISCARD!

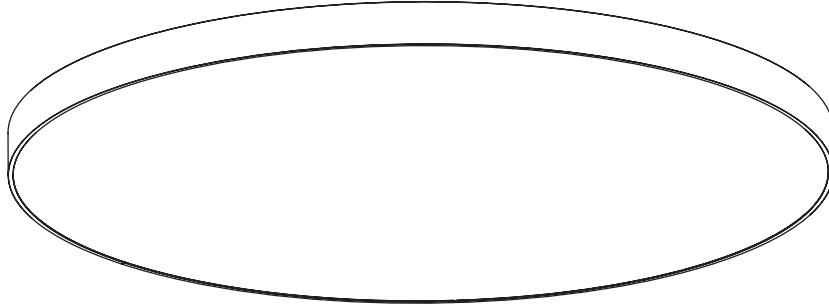

SIGN LEGEND



POWER OFF



ATTENTION



POWER ON



USE ESD GLOVES



DON'T TOUCH THE LED

REQUIRED TOOLS (not included)



PENCIL



SCREWDRIVER

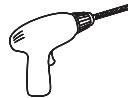

DRILL



ANCHORS
(for appropriate application)



SCREWS

ROUND 1.5' surface

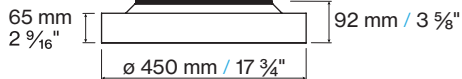

ROUND 2' surface

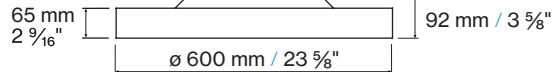
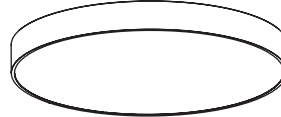

ROUND 3' surface

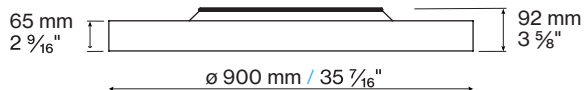
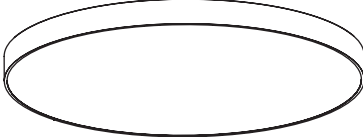

ROUND surface

MOUNTING INSTRUCTIONS

1.5' / 2' MOUNTING POSITIONS

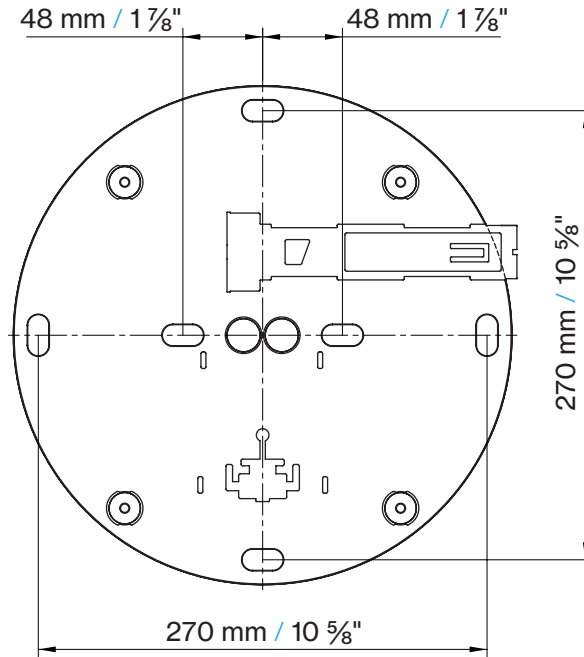



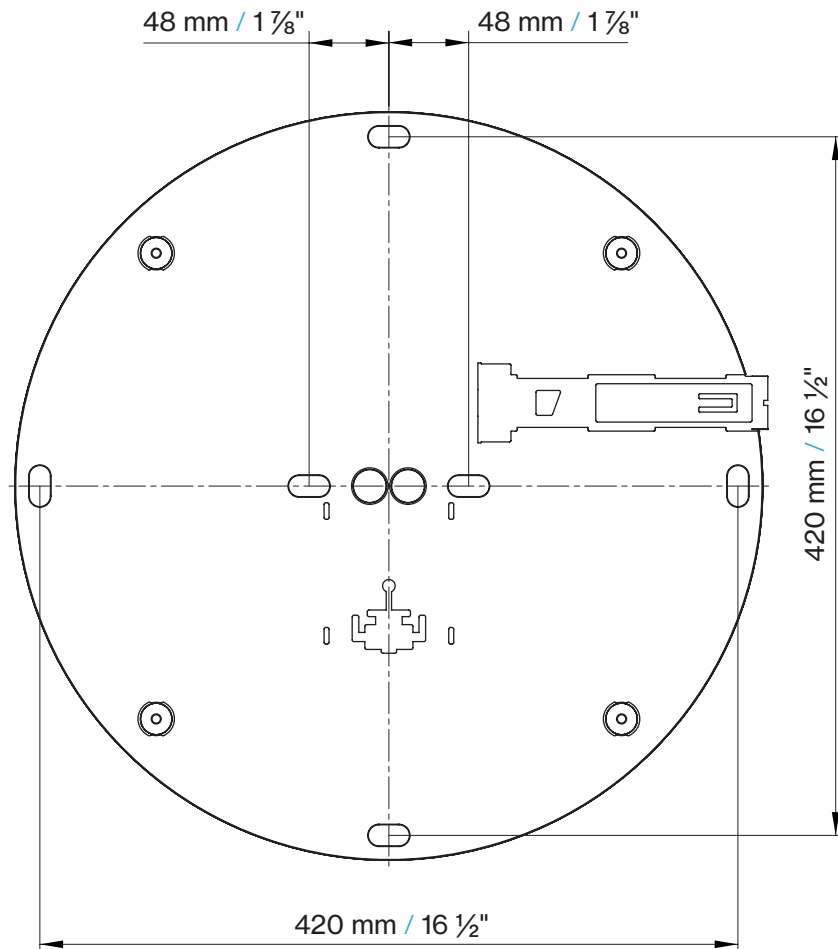

3' MOUNTING POSITIONS

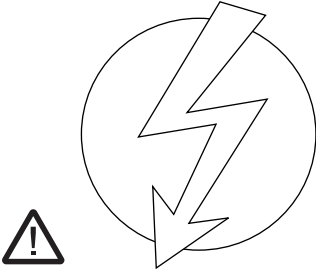
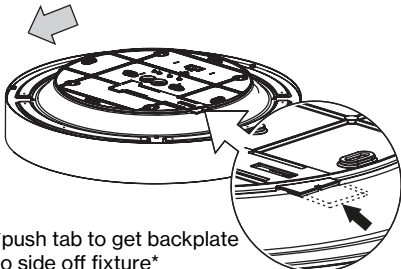
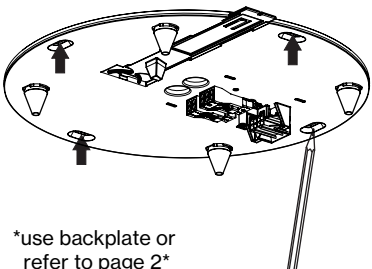
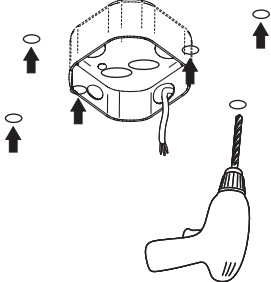
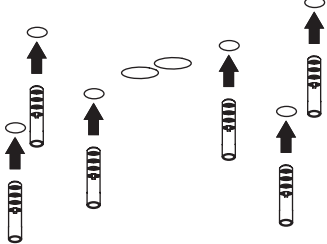
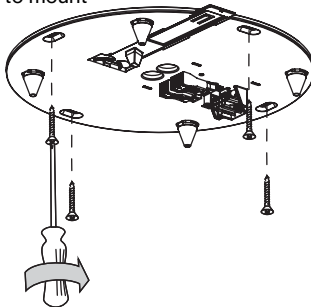
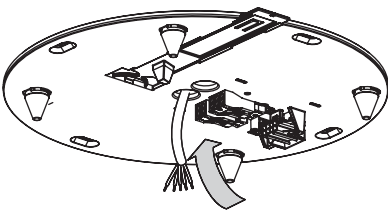
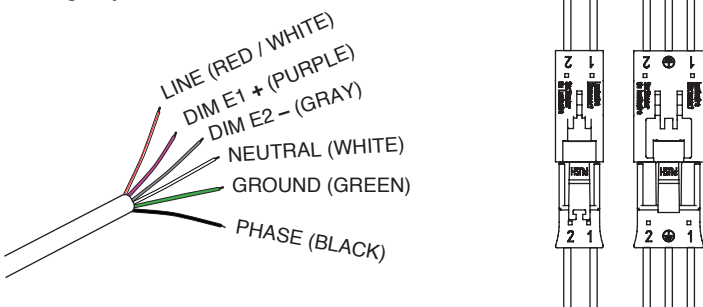
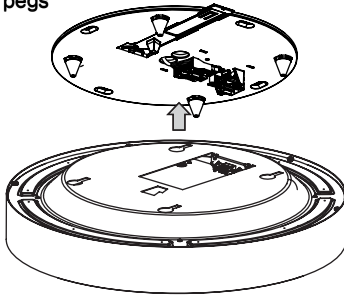

ROUND surface

MOUNTING INSTRUCTIONS

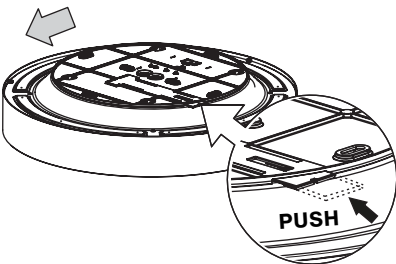
<p>TURN OFF POWER SOURCE BEFORE INSTALLATION</p> 	<p>1. Push tab inward to remove backplate</p>  <p>*push tab to get backplate to side off fixture*</p>	<p>2. Mark dimensions for installation</p>  <p>*use backplate or refer to page 2*</p>
<p>3. Drill holes for bracers</p> 	<p>4. Insert anchors</p> 	<p>5. Use screws to mount backplate</p> 
<p>6. Connect wiring</p> 	<p>Unswitched emergency</p> 	
<p>7. Line fixture up with backplate pegs</p> 	<p>8. To attach, slide the fixture until locked into place</p>  <p> You should hear a "CLICK"</p>	<p>9. Installation complete</p>  <p></p>
<p>To dismount, PUSH tab inward and slide fixture off</p>  <p>Fixture will slide off backplate</p>	<p>Technical Support Hotline</p> <p>Call the Technical Support Hotline from Monday to Friday, 8 AM - 6 PM (EST)</p> <p>Hotline: +1 203 262 9990</p> <p>Or 24/7 via email: service@basolighting.com</p>	

ROUND suspended

MOUNTING INSTRUCTIONS

DO NOT DISCARD!

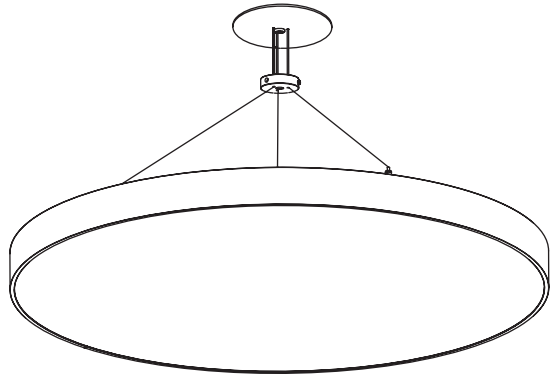

SIGN LEGEND



POWER OFF



POWER ON



DON'T TOUCH THE LED



ATTENTION



USE ESD GLOVES

REQUIRED TOOLS (not included)



PENCIL



SCREWDRIVER



LEVEL



DRILL

ROUND 1.5' suspended

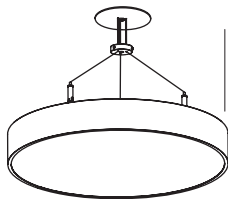

min.
500 mm
19 1/16"

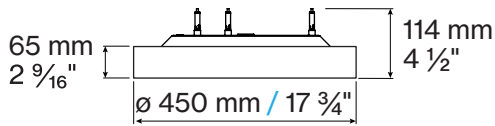

ROUND 2' suspended

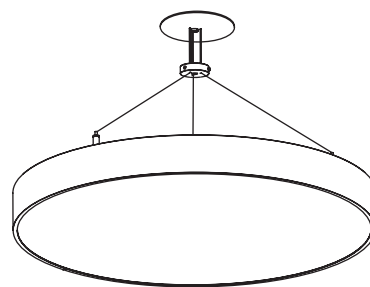

min.
500 mm
19 1/16"

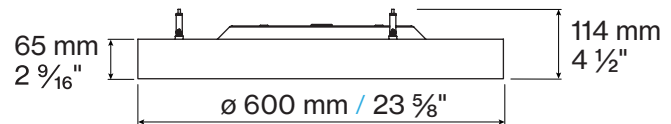

ROUND 3' suspended

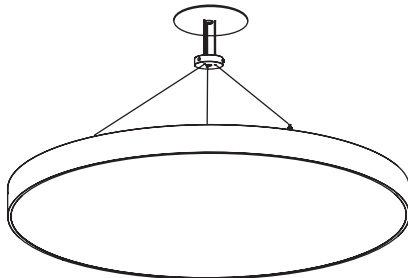



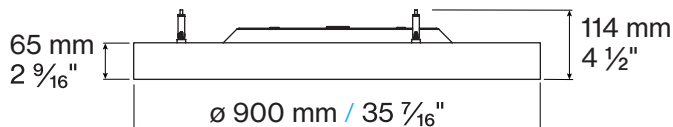



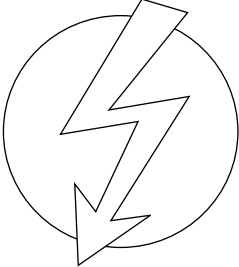

min.
500 mm
19 1/16"

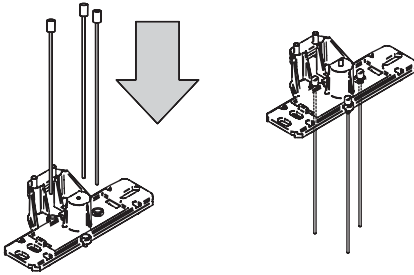
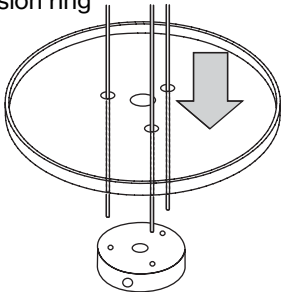
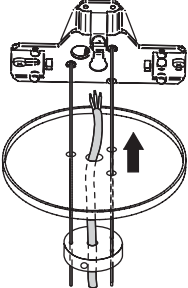
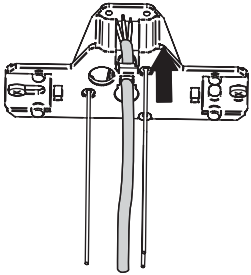
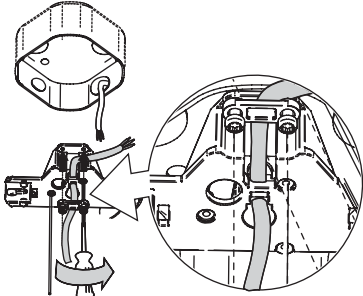

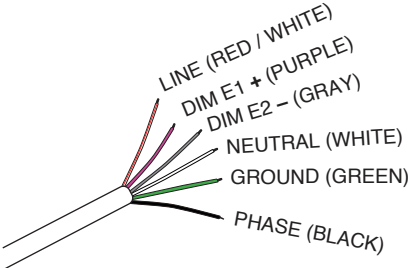
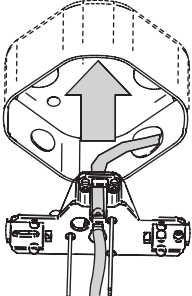
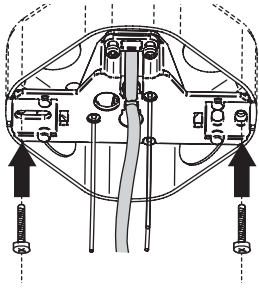
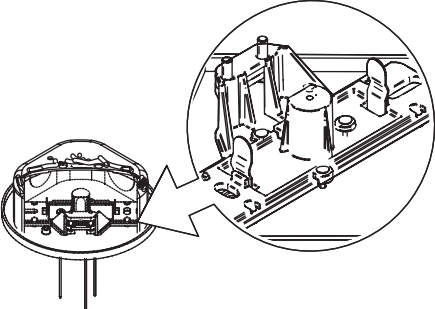
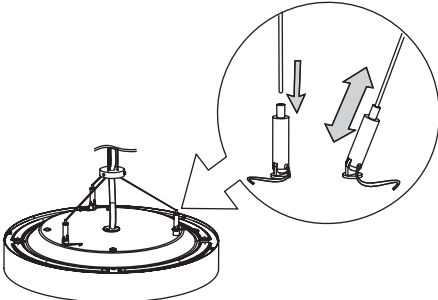
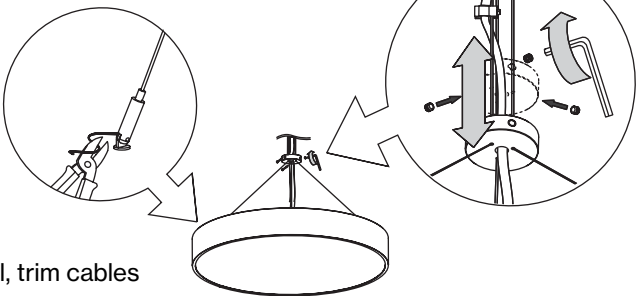
ROUND suspended

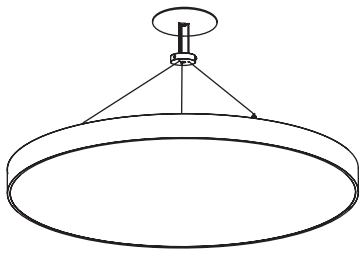
MOUNTING INSTRUCTIONS

<p>TURN OFF POWER SOURCE BEFORE INSTALLATION</p>  	<p>1. Thread aircraft cables through bracket</p> 	<p>2. Thread cables through cover plate and suspension ring</p> 
<p>3. Thread POWER FEED through plate and ring</p> 	<p>4. Thread POWER FEED through bracket</p> 	<p>5. Use screws to secure strain relief</p>  
<p>6. Connect wiring to power source</p>  <p> LINE (RED / WHITE) DIM E1 + (PURPLE) DIM E2 - (GRAY) NEUTRAL (WHITE) GROUND (GREEN) PHASE (BLACK) </p>	<p>7. Place bracket into junction box</p> 	<p>8. Screw bracket into junction box</p> 
<p>9. Clip bracket into cover via springs</p> 	<p>10. Attach aircraft cables to grippers</p> 	
<p>11. Once fixture is level, tighten set screws</p>   <p>Once level, trim cables</p>		<p>12. Installation complete</p>  

ROUND

MOUNTING INSTRUCTIONS

Technical Support Hotline

Call the Technical Support Hotline from
Monday to Friday, 8 AM - 6 PM (EST)

Hotline:
+1 203 262 9990

Or 24/7 via email:
support@basolighting.com

EN Installation, commissioning and maintenance may only be performed by authorized and qualified personnel, taking into consideration these installation instructions and any standards and regulations applicable to the respective area of application. The electrical, mechanical and thermal suitability of the luminaire for the intended area of application must be ensured and the secure fastening of the luminaire after its installation must be controlled. Turn off supply voltage before replacing any lamps (if applicable) as well as before performing any other works on the luminaire (e.g. cleaning) and wait until luminaire and lamp have completely cooled off. Please refer to the installation notes of the lamp manufacturer when inserting, replacing and operating conventional lamps. Use a soft, damp cloth to clean the luminaire. To clean plastic components and reflectors, a standard pH neutral, alcohol-free, non-abrasive cleaning agent may also be used.

Keep these installation instructions in a safe place as reference for any future maintenance works.

1. The lamp is not suitable for outdoor use.
2. The lamp may only be used with a safety guard.
3. Damaged protection glasses and covers have to be replaced immediately.
4. Corrosive chemical products must not be used as this may have a detrimental effect on the luminaire.
5. No liability is accepted for any subsequent change of the luminaire.
6. LEDs are high-quality electronic components! Please avoid touching by hand the LED light emitting surface while assembling or replacing parts and during maintenance work.
7. To avoid damage of the profile, unevenness on the wall or ceiling must be leveled out before assembling the profiles. While assembling the profiles, make sure they do not deform in order to guarantee their proper function.
8. The light source contained in this luminaire shall only be replaced by the manufacturer or his service agent or a similar qualified person.
9. The LED circuit must always be closed, before the converter is connected to the main power. BASO does not assume any liability for damages resulting from nonobservance of this rule.
10. Luminous flux and connected electrical load are subject to an initial tolerance of up to +/-10%. Color temperature is subject to a tolerance of up to +/- 150 Kelvin from the nominal value.

FR Le montage et la maintenance peut être effectué par spécialistes respectant les normes y règles valides. Assurer l'aptitude thermique, mécanique et électrique pour l'emploi prévu et assurer la fixation de la luminaires. Éteindre la tension avant de changer les lampes (si applicable) ou avant de réaliser travaux (p.ex nettoyage) à la luminaires. Attendre jusqu'à ce que la luminaires et les lampes ont fraîchit complètement. Merci de bien vouloir vous référer aux notes d'installation du fabricant de la lampe lors de l'insertion, le remplacement et la mise en route, avec des lampes conventionnelles. Pour nettoyer la luminaires utiliser un drap humide et doux. Pour nettoyer les parties du plastique ou les réflecteurs on peut utiliser encore un produit de nettoyage sans alcool qui ne fraye pas le matériel. Garder cette notice de montage pour possibles travaux de maintenance.

1. La luminaires n' est pas apte pour l'utilisation extérieur.
2. Utiliser la luminaires seulement avec un dispositif de sécurité
3. Changer immédiatement des verres de sécurité défectueux ou bien des écrans de protection.
4. Évitez tout contact de la lampe avec de produits chimiques corrosifs.
5. Nous déclinons toute responsabilité en cas de modifications ultérieures.
6. Des LEDs sont des composants électroniques de haute qualité! Éviter tout contact direct de la surface de sorti de lumière de la LED avec les mains lors du montage ou des les travaux de maintenance de la lampe.
7. Pour éviter l'endommagement du profil, il est nécessaire de compenser les irrégularités du mur ou du plafond avant le montage des profils. Pour garantir un fonctionnement irréprochable des profils, il ne faut pas déformer les profils lors du montage.
8. La source du luminaires peut être remplacé uniquement par le fabricant ou un tiers habilité.
9. Il faut que le circuit de LED soit fermé avant de connecter le convertisseur. BASO ne assume pas la garantie si cette norme ne se respecte pas.
10. La puissance et le flux lumineux affichent d'origine une tolérance de +/-10 %. Tolérance de la couleur de température : +/- 150 Kelvin.

ES La instalación, la puesta en marcha y el mantenimiento sólo deben realizarse por personal especializado considerando esta guía de instalación y todas las normas y reglamentaciones vigentes. Asegurarse de la aptitud eléctrica, mecánica y térmica de la luminaria para la aplicación prevista y comprobar la fijación segura de la luminaria después de su instalación. Apagar siempre la corriente antes de cambiar la lámpara (en caso justificado) o de realizar algún otro trabajo en esta (p.ej. Limpieza). Esperar hasta que se enfríen la luminaria y la lámpara completamente. Tener en cuenta las instrucciones de montaje del fabricante al colocar, cambiar y utilizar lámparas convencionales. Para la limpieza de la luminaria utilizar un paño suave y húmedo. Para limpiar componentes de plástico y reflectores puede usar también un limpiador pH neutral y sin alcohol que no roce el material. Guardar esta guía de instalación para trabajos de mantenimiento.

1. La luminaria no es apta para utilizarla en el exterior.
2. La luminaria solo debe accionar con un dispositivo de seguridad.
3. Cambie de inmediato los vidrios y las tapas de protección dañados.
4. Químicos que tienen efectos corrosivos no deben influir en la luminaria.
5. Para modificaciones futuras en la luminaria no se asume ninguna responsabilidad.
6. Los LED son componentes electrónicos de alta calidad! Por favor durante el montaje o el mantenimiento evite el contacto directo con la superficie de emisión.
7. Para evitar danos en el perfil, los desniveles de las paredes y techos deben ser enrasados antes del montaje de los perfiles. Para garantizar su buen funcionamiento, los perfiles no deben sufrir deformaciones durante el montaje.
8. La fuente luminosa contenida en esta luminaria debe ser reemplazada únicamente por el fabricante o su agente de servicio o similar persona cualificada.
9. El circuito LED debe ser cerrado antes de conectar el convertidor. BASO no asume garantía si esta norma no se respeta.
10. La potencia original y el flujo luminoso presentan una tolerancia de +/-10%. Tolerancia de temperatura de color: +/- 150 Kelvin.

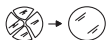

The lamp may only be operated with its full protective cover!



L'apparechio necessita del relativo vetro di protezione!

Sólo usar la luminaria con su cobertura de seguridad completa!

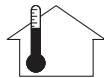

Recommended room temperature: 77 °F.

Temperatura ambiente recomendada: 77 °F.

Température ambiante recommandée: 77 °F.



Don't touch the LED



Use gloves.

Use guantes.

Utiliser des gants.