

BASO 2.5 DIRECT



CERTIFICATIONS & COMPLIANCE



FEATURES



PERFORMANCE

- Up to 106lm/W efficiency
- 455 / 750lm/ft
- CRI > 80 & CRI > 90
- Damp rated

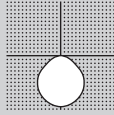

MOUNTING

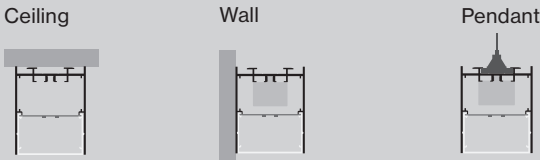

PATTERNS

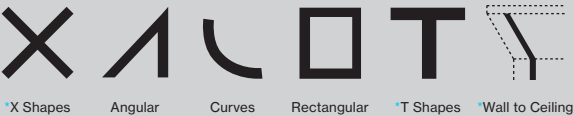

*X Shapes Angular Curves Rectangular *T Shapes *Wall to Ceiling
For customization, please contact customer service

FIELD-CUTTABLE FLEX

Down to 1/16"



[link to video](#)

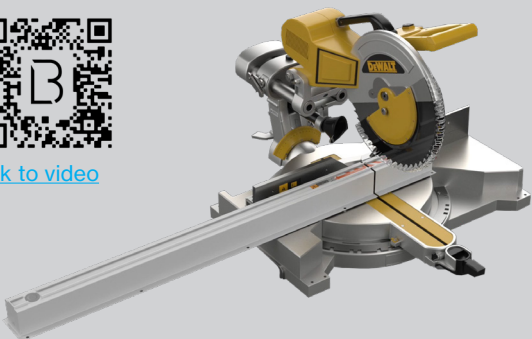

Catalog Number Example

BASO 2.5-SUR-BL-OP-30K-C80-UNV-010V-0500LF-NLC-ST-96IN

A B C D E F G H J K L M

A RANGE

BASO 2.5 BASO 2 . 5

B MOUNTING

CS Surface	SUR
Surface in-line ACT T-BAR	SAT
Surface in-line ACT SLOT	SAS
Surface ACT center tile	SAC
CS Pendant	PDT
Pendant in-line ACT T-BAR	PAT
Pendant in-line ACT SLOT	PAS
Pendant ACT center tile	PAC

pendant suspension set includes cable suspension and one white power feeder with a white junction box cover

Wall mounted WAL

for black power feeds or junction box covers, please contact customer service

C COLOR

CS White	WH
CS Black	BL
Gray	GR
Custom color RAL	XX

trimless version available in white only

D LENS

HP opal cover OP

E CCT

2700K	27K
CS 3000K	30K
CS 3500K	35K
4000K	40K
Tunable White 18-40K	18 - 40K
Tunable White 27-65K	27 - 65K

F CRI

CRI > 80	C80
CRI > 90	C90

G VOLTAGE

120V / 277V UNV

H DIMMING

CS 0-10V 1%	010V
Lutron EcoSystem	LES1
Quantum, Vive, GRAFIK Eye, HomeWorks	
Power over ethernet	POEC
consult customer service for compatibility	
Custom dimming	XXXX
consult customer service for compatibility	

I SENSOR (optional)

Integrated Sensor SEN
consult customer service for sensor request

J OUTPUT LM/FT

CS 500lm/ft 100% ‡	0500LF
CS 750lm/ft 100% ‡	0750LF
CS 1000lm/ft 100% ‡	1000LF
Custom lm/ft	XXXXLF

custom lumen up to 1200 lm/ft

K CIRCUIT / EM

CS Single circuit	*
EMC night light circuit	NLC
EMB available in 4ft and 8ft	EM#

* leave blank

L SHAPE / PATTERN

CS Linear / straight	ST
CS Linear / straight + flex inset	SF

includes 1ft. field-cutttable section; only available for 4' and 8' segments

L-shape	LS
□-shape (rectangular shape)	RS
U-shape	US
Custom shape	XX

M DIMENSIONS IN INCH

Linear 2'	24IN
CS Linear 4'	48IN
CS Linear 6'	72IN
CS Linear 8'	96IN
Linear custom	###IN
Linear flex inset	###IN

includes 4' to 3' field-cutttable section

L-Shape	###X###IN
U-Shape	###X###X###IN
□-Shape	###X###IN

for curved options, please see our SHAPES brochure

for lengths including flex insets, round up to the nearest total foot length

N CERTIFICATION (optional)

Red List Approved DRLA

Technical data

BASO 2.5 DIRECT

LUMEN OUTPUT MULTIPLIER*

Color Temperature

CRI

Delivered Lumens	CCT	CRI	Input Watts	Luminaire Efficacy	LUMEN OUTPUT MULTIPLIER*	
					Color Temperature	CRI
500 lm/ft †	4000K	CRI > 80	4.1 W/ft	122 lm/W	4000K	1
750 lm/ft †	4000K	CRI > 80	6.3 W/ft	119 lm/W	3500K	0.96
1000 lm/ft †	4000K	CRI > 80	8.9 W/ft	112 lm/W	3000K	0.95
					2700K	0.91
						80+
						90+

*To calculate the color temperatures >4000K and CRI 90, multiply the values in the lumen output tables.

Patterns top view

LINEAR

A	FIXTURES	CODE
48"	1 × 4' linear	ST - 0 4 F T
96"	1 × 8' linear	ST - 0 8 F T
144"	3 × 4' linear	ST - 1 2 F T



L-SHAPE

A / B	FIXTURES	CODE
48" / 48"	2 × 2' linear + 1 × 2' × 2' corner	LS - 0 4 X 0 4 F T
48" / 96"	1 × 2' linear + 1 × 6' linear + 1 × 2' × 2' corner	LS - 0 4 X 0 8 F T
96" / 96"	2 × 6' linear + 1 × 2' × 2' corner	LS - 0 8 X 0 8 F T

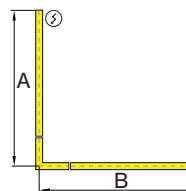

□-SHAPE (rectangular shape)

A / B	FIXTURES	CODE
48" / 48"	4 × 2' × 2' corner	RS - 0 4 X 0 4 F T
48" / 96"	2 × 4' linear + 4 × 2' × 2' corner	RS - 0 4 X 0 8 F T
96" / 96"	4 × 4' linear + 4 × 2' × 2' corner	RS - 0 8 X 0 8 F T

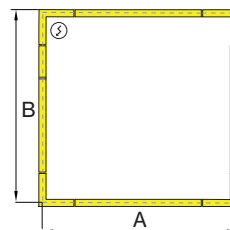

U-SHAPE

A / B / C	FIXTURES	CODE
48" / 48" / 48"	2 × 2' linear + 2 × 2' × 2' corner	US - 0 4 X 0 4 X 0 4 F T
48" / 96" / 48"	1 × 4' linear + 2 × 2' linear + 2 × 2' × 2' corner	US - 0 4 X 0 8 X 0 4 F T
48" / 144" / 48"	1 × 8' linear + 2 × 2' linear + 2 × 2' × 2' corner	US - 0 4 X 1 2 X 0 4 F T

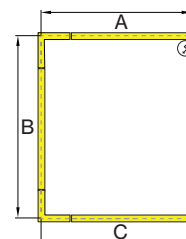

DIMENSIONS

BASO 2.5

SURFACE
direct

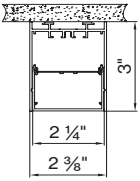

linear 4ft / 8ft

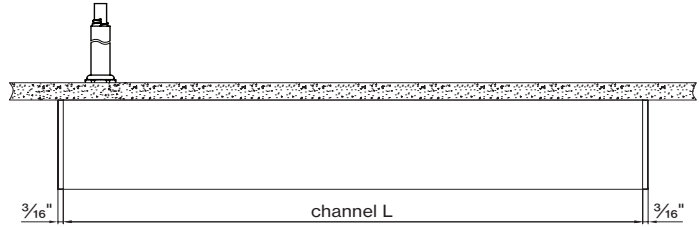

PENDANT
direct

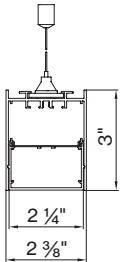

direct / indirect

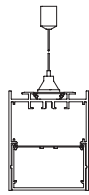

linear 4ft / 8ft

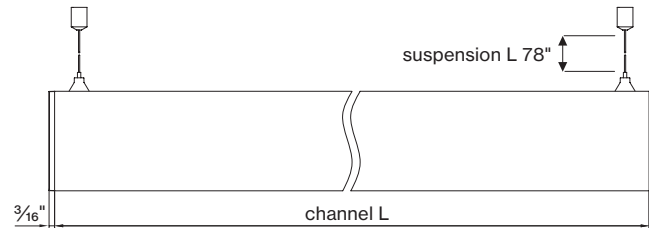

BASO 2.5 SPECIALITY MOUNTING

SURFACE
in-line ACT TBAR

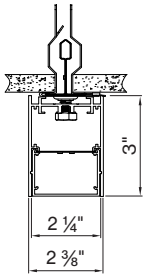

SURFACE
in-line ACT SLOT

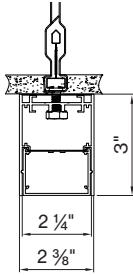

SURFACE
ACT center tile

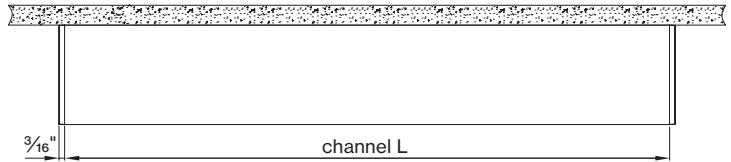
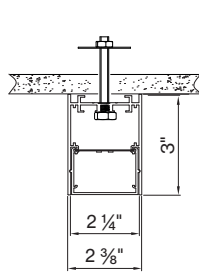

PENDANT
ACT TBAR

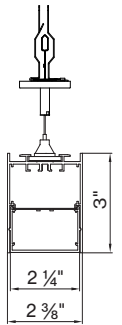

PENDANT
in-line ACT SLOT

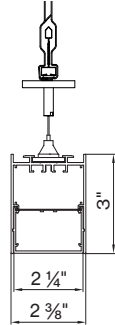

PENDANT
ACT center tile

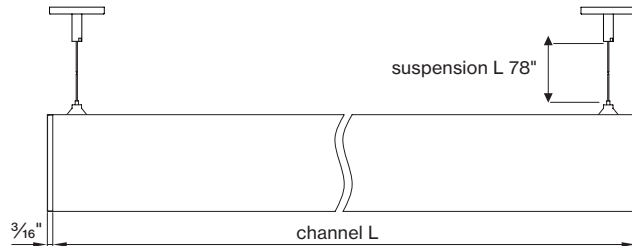
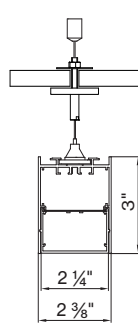

Declare.

BASO 1.2 2.5 4.0
BASO 2.5
Bosch Lighting Inc.
10000 W. 10th Street, Suite 100
Overland Park, KS 66204
www.boschlighting.com
© 2025 Bosch Lighting Inc. All rights reserved.

BASO mounting instructions

Get access to the BASO 2.5 mounting instructions faster by scanning the QR code.

<https://www.basolighting.com/resources/mounting-instructions/baso>

